



13th World Conference on Earthquake
Engineering
Vancouver, B.C., Canada
August 1-6, 2004
Paper No. 1179

Post-Earthquake Damage Evaluation for R/C Buildings Based on Residual Seismic Capacity

Masaki MAEDA¹, Yoshiaki NAKANO² and Kang Seok LEE³

SUMMARY

In this paper described is the basic concept of the Guideline for Post-earthquake Damage Assessment of RC buildings, revised in 2001, in Japan. This paper discusses the damage rating procedures based on the residual seismic capacity index R , the ratio of residual seismic capacity to the original capacity, that is consistent with the Japanese Standard for Seismic Evaluation of Existing RC Buildings, and their validity through calibration with observed damage due to the 1995 Hyogoken-Nambu (Kobe) earthquake. Good agreement between the residual seismic capacity ratio and damage levels was observed. Moreover, seismic response analyses of SDF systems were carried out and it is shown that the intensity of ultimate ground motion for a damaged RC building structure can be evaluated conservatively based on the R -index in the Guideline.

INTRODUCTION

To restore an earthquake damaged community as quickly as possible, well-prepared reconstruction strategy is most essential. When an earthquake strikes a community and destructive damage to buildings occurs, quick damage inspections are needed to identify which buildings are safe and which are not to aftershocks. However, since such quick inspections are performed within a restricted short period of time, the results may be inevitably coarse. In the next stage following the quick inspections, damage assessment should be more precisely and quantitatively performed, and then technically and economically sound solution should be applied to damaged buildings, if rehabilitation is necessary. To this end, a technical guide that may help engineers find appropriate actions required in a damaged building is needed, and the Guideline for Post-earthquake Damage Evaluation and Rehabilitation [1] originally developed in 1991 was revised in 2001 considering damaging earthquake experience in Japan.

The Guideline describes damage evaluation basis and rehabilitation techniques for three typical structural systems, i.e., reinforced concrete, steel, and wooden buildings. Presented in this paper are outline and basic concept of the Guideline for reinforced concrete buildings. This paper discusses the damage rating

¹ Department of Architecture and Building Science, Tohoku University, Sendai, Japan
Email: maeda@struct.archi.tohoku.ac.jp

² Institute of Industrial Science, The University of Tokyo, Tokyo, Japan
Email: iisnak@iis.u-tokyo.ac.jp

³ Building and Fire Research Laboratory, National Institute of Standards and Technology
Email: kslee@nist.gov

procedures based on the residual seismic capacity index that is consistent with the Japanese Standard for Seismic Evaluation of Existing RC Buildings [2], and their validity through calibration with observed damage due to the 1995 Hyogoken-Nambu (Kobe) earthquake and seismic response analyses of SDF systems.

BASIC CONCEPT OF POST-EARTHQUAKE DAMAGE EVALUATION

Residual Seismic Capacity Ratio, R

In this paper, damage level of a building structure was evaluated by residual seismic capacity ratio R , which is defined as the ratio of post-earthquake seismic capacity to the original capacity. Seismic Evaluation Standard [2], which is most widely applied to existing reinforced concrete buildings in Japan, was employed to evaluate the seismic capacity of a building. In the Seismic Evaluation Standard, seismic performance index of a building is expressed by the I_s -index. The basic concept of I_s -index appears in APPENDIX. Residual seismic capacity ratio R is given by Eq.(1).

$$R = \frac{D I_s}{I_s} \times 100 \quad (\%) \quad (1)$$

where, I_s : original seismic performance index, $D I_s$: post-earthquake seismic performance index

Estimation of Post-earthquake Seismic Capacity of Building

The original seismic performance I_s -index of a building can be calculated from lateral resistance and deformation ductility of structural members in accordance with the Seismic Evaluation Standard. On the other hand, residual resistance and deformation ductility in the damaged structural members are needed to be evaluated in order to quantify post-earthquake seismic performance index $D I_s$. Idealized lateral force-displacement relationships for ductile and brittle columns are shown in **Figure 1** with damage class defined in **Table 1**. **Table 1** shows damage classification of structural members in the Guideline for Post-earthquake Damage Evaluation [1].

Table 1: Damage Class For RC Structural Members [1]

Damage Class	Observed Damage on Structural Members
I	Some cracks are found. Crack width is smaller than 0.2 mm.
II	Cracks of 0.2 - 1 mm wide are found.
III	Heavy cracks of 1 - 2 mm wide are found. Some spalling of concrete is observed.
IV	Many heavy cracks are found. Crack width is larger than 2 mm. Reinforcing bars are exposed due to spalling of the covering concrete.
V	Buckling of reinforcement, crushing of concrete and vertical deformation of columns and/or shear walls are found. Side-sway, subsidence of upper floors, and/or fracture of reinforcing bars are observed in some cases.

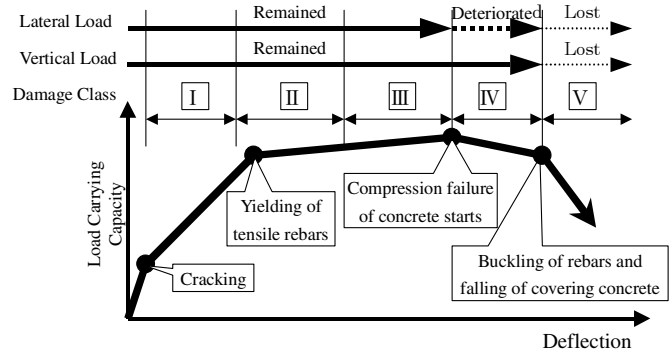

(a) Ductile member

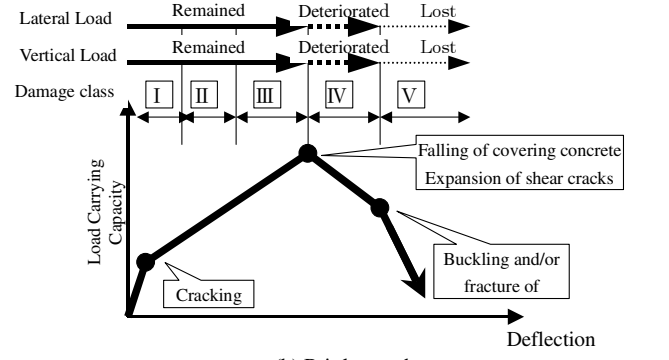

(b) Brittle member

Figure 1: Idealized lateral force-displacement relationships and damage class

In the Seismic Evaluation Standard, most fundamental component for I_s -index is E_0 -index, which is basic structural seismic capacity index calculated from the product of strength index (C), and ductility index (F). Accordingly, deterioration of seismic capacity was estimated by energy dissipation capacity in lateral force- displacement curve of each member, as shown in **Figure 2**. Seismic capacity reduction factor η is defined by Eq.(2).

$$\eta = \frac{E_r}{E_t} \tag{2}$$

where, E_d : dissipated energy, E_r : residual absorbable energy,

E_t : entire absorbable energy ($E_t = E_d + E_r$).

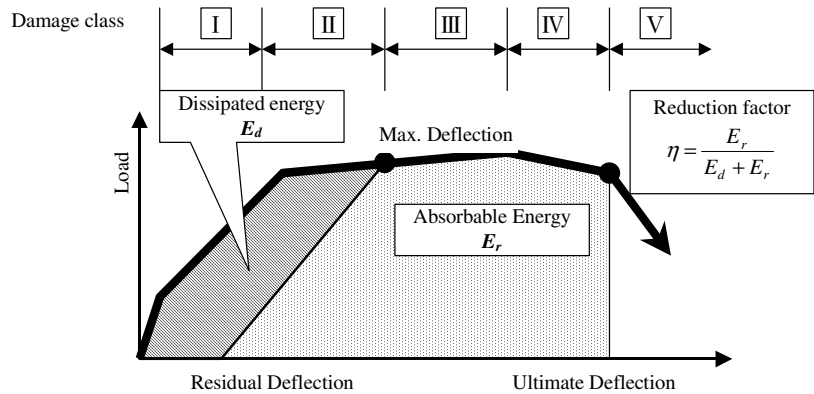

Figure 2: Seismic capacity reduction factor η

Evaluation of the seismic capacity reduction factor η based on experimental results

The seismic capacity reduction factor η for ductile flexural members was investigated using authors' test results [3,4]. The details of the specimens are illustrated in **Figure 3**. Four beam specimens were tested under anti-symmetric bending and axial restraint force applied in proportion to the measured axial elongation. The stiffness constant for the axial force was selected as 1000 kN/cm or 4000 kN/cm, representing the lateral restraint stiffness of columns in prototype frame structures. The shear span ratio was 1.0 or 2.0. Sufficient lateral reinforcement was provided not only to prevent from brittle shear failure before flexural yielding but also to ensure adequate deformation capacity in the hinge region. The specimens were subjected to two cycles at rotation angles of 1/200, 1/100, 1/67, 1/50, 1/33 rad after the first cycle at a rotation angle of 1/400rad.

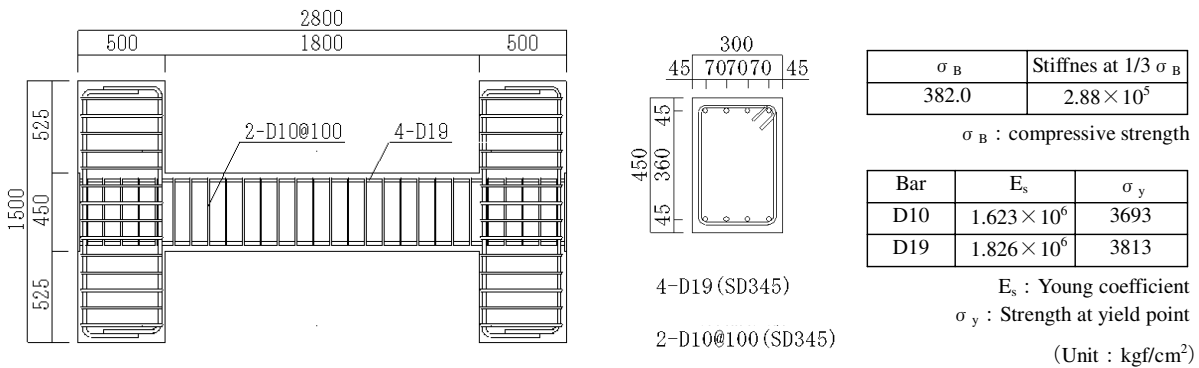

Figure 3: Details of the beam specimen

Figure 4 shows the observed shear force-lateral displacement relations. The relationship between maximum residual crack widths and the lateral displacement is shown in **Figure 5**. In the experiment, all the flexural crack widths were measured by crack gauges along the top and bottom surfaces of a specimen at the peak in each cycle and at the moment when the lateral force was unloaded. (see **Figure 6**).

Longitudinal bars yielded in each specimen at the rotation angle of the order of 1/200rad. As can be seen in **Figure 5**, residual crack widths were smaller than 0.2mm, which corresponds to the "damage class I (slight damage)", until flexural yielding occurred in a cycle at 1/200rad. In performance-based design point of view, the result indicates that flexural yielding may be defined as one of the criteria for the serviceability limit state in structural members of ductile flexural type. After flexural yielding, the maximum residual crack increased markedly with increase in the lateral displacement. When specimens reached maximum lateral force at the rotation angle of 2/100-3/100rad, the maximum residual crack widths were about 2mm and damage class was III or IV.

From the test results, the seismic capacity reduction factor η , defined in **Figure 2**, was evaluated. The entire energy dissipation E_d was calculated from positive envelopes of shear force-lateral displacement curve (see **Figure 4**). Ultimate displacement was assumed as the rotation angle when shear force decrease to 80% of maximum force. The relationships between seismic capacity reduction factor η and maximum residual crack widths $maxW_0$ are shown in **Figure 7**. From the figure, linearly decreasing relation is observed.

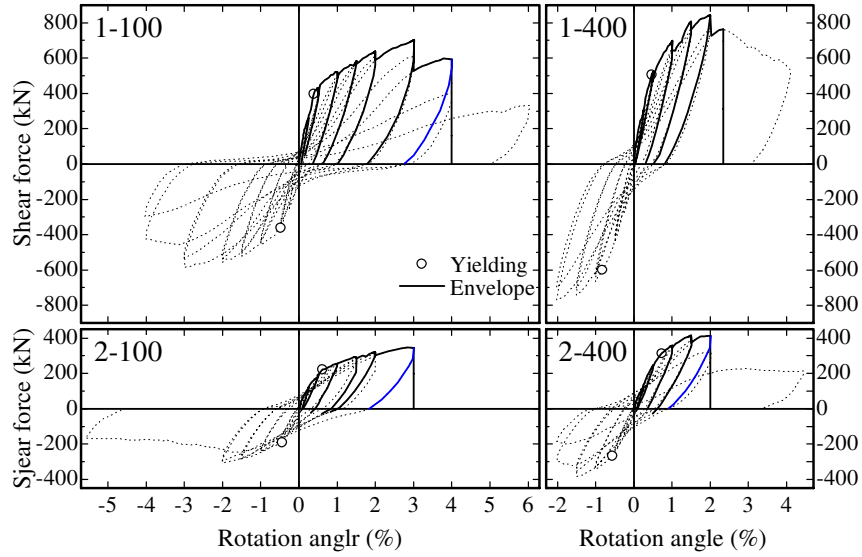

Figure 4: Shear Force-Lateral Displacement Relations

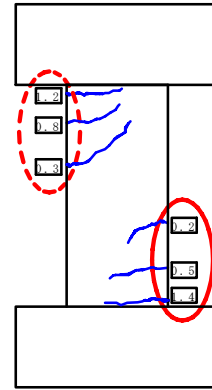
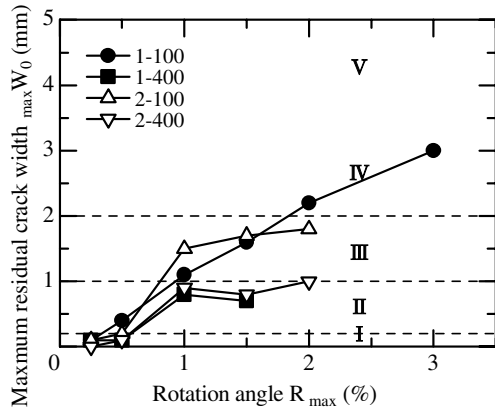
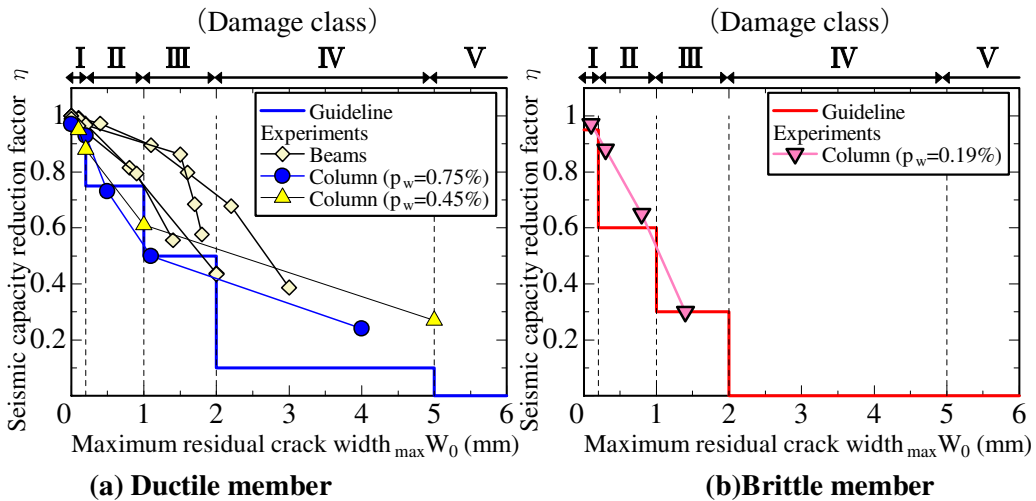

Figure 5: Maximum residual crack width vs. rotation angle

Figure 6: Measurement of crack width



(a) Ductile member

(b) Brittle member

Figure 7: Maximum residual crack width $_{max}W_0$ vs. seismic capacity reduction factor η

Evaluation of the seismic capacity reduction factor η based on an analytical model

A simple analytical model was introduced in order to formulate the relation of maximum residual crack width $_{max}w_0$, and the seismic capacity reduction factor η . As shown in **Figure 8**, deformation of a column was assumed to be consist of two components: flexural and shear deformation. If the column is idealized as a rigid body, the flexural deformation of the column can be represented by the rotation of the rigid body [3,4]. This assumption gives an estimation of flexural deformation R_f , due to total flexural crack widths $\sum w_f$ by Eq.(3).

$$R_f = \frac{\sum w_f}{D} \quad (3)$$

If shear deformation due to shear cracks is idealized as shown in **Figure 8(b)**, shear deformation R_s due to total shear crack widths $\sum w_s$ can be formulated as Eq.(4).

$$R_s = \frac{\sum w_s \cdot \sin \theta}{h_0} \quad (4)$$

where, h_0 :clear span height of a column, θ : angle of shear crack to the horizontal plane (assume $\theta = 45$ degree).

Residual deformation of a column R_0 is obtained by the summation of two components.

$$R_0 = R_{0f} + R_{0s} = \frac{\sum w_f}{D} + \frac{\sum w_s \cdot \sin \theta}{h_0} \quad (5)$$

Rearranging Eq.(5) leads to Eqs.(6) and (7).

$$_{max} w_{0f} = \frac{\alpha \cdot D}{n_f} R_0 \quad (6)$$

$$_{max} w_{0s} = \frac{(1-\alpha)h_0}{n_s \sin \theta} R_0 \quad (7)$$

$$\text{where, } \alpha = \frac{R_{0f}}{R_0}, \quad n_f = \frac{\sum w_f}{_{max} w_{0f}}, \quad n_s = \frac{\sum w_s}{_{max} w_{0s}}$$

Substituting appropriate value into α , n_f , and n_s , the relation of maximum residual crack width $_{max}w_0$ with residual deformation R_0 is evaluated, although the ratio of flexural deformation α , and the ratio of total crack width to maximum crack width n_f , n_s change in accordance with failure mode, shear-span-to-depth ratio h_0/D , construction age, lateral reinforcement ratio and so on.

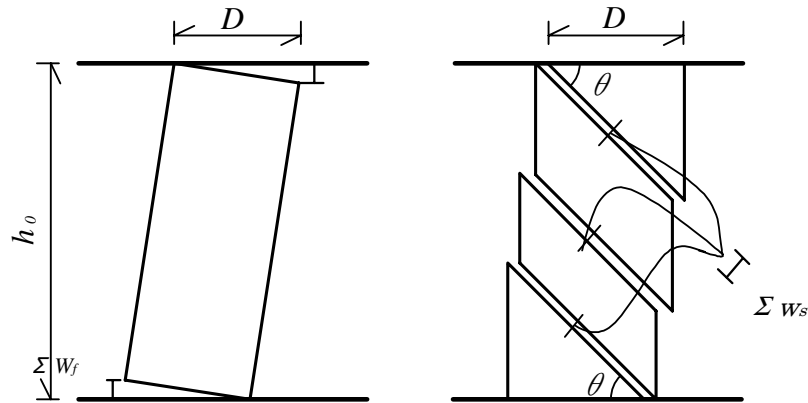

(a) Flexural deformation

(b) Shear deformation

Figure 8: Idealization of flexural and shear deformation components

Analytical results for seismic capacity reduction factor η were plotted in Figure 7. From the experimental results, $\alpha=3/4$, $n_f=2$ and $n_s=4$ were used for a ductile member. $\alpha=1/2$, $n_f=2$ and $n_s=2$ were assumed for a brittle member. As can be seen in **Figure 7(a)**, analytical results agreed well with experimental results. From these results, seismic capacity reduction factor η for ductile and brittle members were determined as shown in **Table 2**.

Table 2: seismic capacity reduction factor η

Damage Class	Ductile Column	Brittle Column	Wall
I	0.95	0.95	
II	0.75	0.6	
III	0.5	0.3	
IV	0.1	0	
V	0	0	

APPLICATION TO RC BUILDINGS DAMAGED DUE TO RECENT EARTHQUAKES IN JAPAN

The proposed evaluation method was applied to reinforced concrete buildings damaged due to recent earthquakes such as 1995 Hyogo-ken-nambu Earthquake.

Approximation of lateral strength and ductility in members

One of main purposes of damage level classification is to grasp the residual seismic capacity as soon as possible just after the earthquake, in order to access the safety of the damaged building for aftershocks and to judge the necessity for repair and restoration. For this purpose, need of complicated procedure, i.e. calculation of strength and ductility of structural member based on material and sectional properties, reinforcing details etc, is inconvenient. Accordingly, a simplified method was developed by approximating the lateral strength and ductility. Following assumptions were employed in the approximation.

- (1) Vertical members are categorized into five members and normalized lateral strengths \bar{C} of the five categories are assumed as shown in **Table 3**. These values were evaluated from cross section area and average shear stress for typical low-rise reinforced concrete buildings in Japan.
- (2) Ductility factor F of each vertical member is assumed 1.0.
- (3) The original and residual capacities of a building are estimated by the summation of the original and residual capacities of vertical members in the damaged story. Therefore residual seismic capacity ratio R is calculated by Eq.(8).

$$R = \frac{\sum \eta \bar{C} F}{\sum \bar{C} F} \quad (8)$$

Table 3: Categories of vertical members and normalized lateral strengths \bar{C}

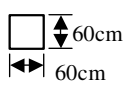
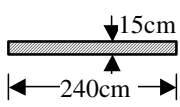
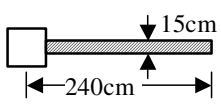
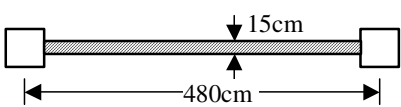
	Column	Wall without boundary column	Column with side wall	Wall with boundary columns
Section				
Shear stress τ	1 N/mm ²	1 N/mm ²	2 N/mm ²	3 N/mm ²
\bar{C}	1	1	2	6

Application to damaged buildings

The proposed damage evaluation method was applied to reinforced concrete buildings damaged due to recent earthquakes. Objective buildings are listed in **Table 4**. Buildings No.1-10 were beam-column moment frame structures in the longitudinal direction, in which major damage was observed. The others are wall-frame structure. First floor plan of building No.11 and No.12 are shown in **Figure 9**.

Table 4: Objective buildings

No.	Usage	Construction age	Number of Story	Residual seismic capacity R		Damage level
				Approximated R_1	Accurate R_2	
1	School	1972 1974	4	54.1	48.1	Severe
2	School	1972 1974	4	33.5	24.0	Severe
3	School	1972 1974	4	38.4	51.3	Severe
4	School	1976	3	80.0	81.1	Minor
5	School	1970 1976	4	71.9	76.6	Moderate
6	School	1959 1960	3	34.9	35.9	Severe
7	School	1967	3	71.3	71.5	Moderate
8	School	1967	3	16.0	13.6	Severe
9	Community center	1977	3	89.0	88.4	Minor
10	Community center	1969	3	57.6	54.3	Severe
11	Apartment	1968	10	23.5	27.5	Severe
12	Office	1969 1970	6	50.0	59.0	Severe

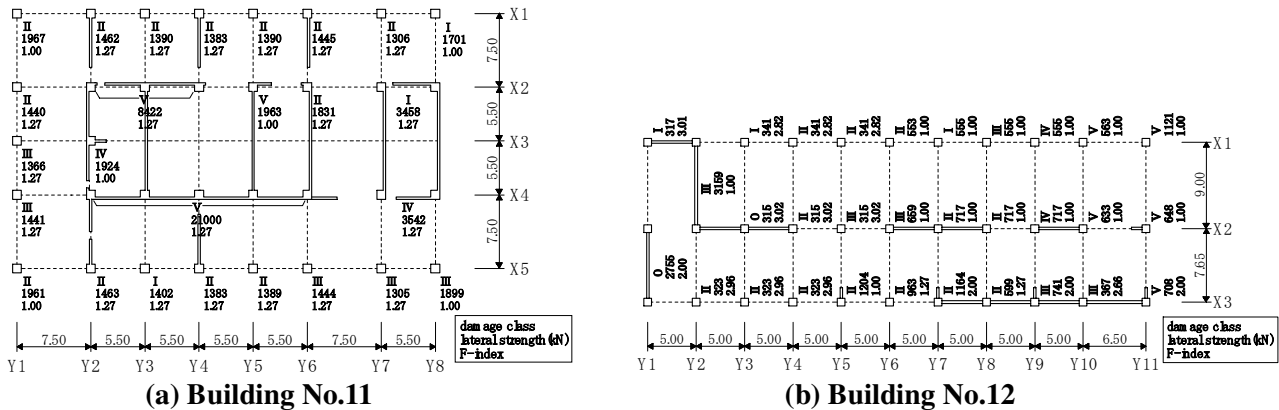

Figure 9: First floor plan and damage class in structural members

As shown in **Figure 9**, severer damage was observed in shear walls in the building No.11 and lateral strengths of shear walls were relatively higher than the assumption in **Table 3**. On the other hand, lateral strengths of shear walls in the building No.12 were relatively lower.

Approximated value of Residual seismic capacity ratio R_1 was compared with accurate value R_2 , which

was evaluated from calculated lateral strength and ductility based on material and sectional properties, reinforcing details, in **Figure 10**. From the figure, approximated value R_1 agrees with accurate value R_2 not only for frame structure but also for wall-frame structure.

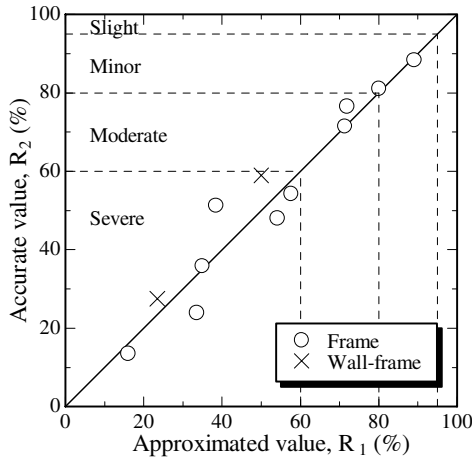

Figure 10: Comparison R_1 and R_2

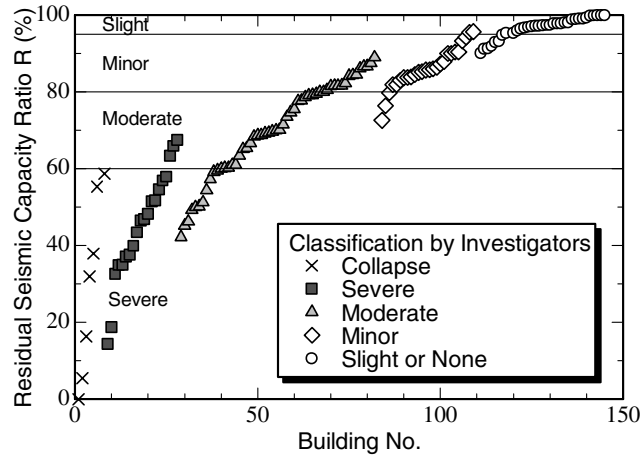

Figure 11: Residual seismic capacity ratio R and damage level classification

The residual seismic capacity ratio R of about 150 reinforced concrete school buildings, including above mentioned buildings, are shown in **Figure 11** together with damage levels estimated by the engineering judgment of investigators. As can be seen in the figure, no significant difference between damage levels and residual seismic capacity ratio R can be found although near the border some opposite results are observed.

The horizontal lines in **Figure 11** are borders between damage levels proposed in the Damage Evaluation Guideline.

[slight]	$R \geq 95$ (%)
[minor]	$80 \leq R < 95$ (%)
[moderate]	$60 \leq R < 80$ (%)
[severe]	$R < 60$ (%)
[collapse]	$R \approx 0$

The border between slight and minor damage was set $R=95\%$ to harmonize “slight damage” to the serviceability limit state. Almost of severely damaged and about 1/3 of moderately damaged buildings were demolished and rebuilt after the earthquake according to the report of Hyogo Prefecture. Therefore, if the border between moderate and severe damage was set $R=60\%$, “moderate damage” may correspond to the reparability limit state.

CALIBRATION OF R INDEX WITH SEISMIC RESPONSE OF SDF SYSTEMS

Outline of Analysis

In the Damage Evaluation Guideline, the seismic capacity reduction factor η was defined based on absorbable energy in a structural member, which was evaluated from an idealized monotonic load-deflection curve as shown in **Figure 2** and accordingly the effect of cyclic behavior under seismic vibration was not taken into account. Therefore nonlinear seismic response analyses of a single-degree-of-freedom (SDF) system were carried out and validity of the residual seismic capacity ratio R in the Guideline was investigated through comparison of responses for damage and undamaged

SDF systems.

Residual seismic capacity ratio based on seismic response, R_{dyn} , was defined by the ratio of the intensity of ultimate ground motion after damage to that before an earthquake (**Figure 12**). The ultimate ground motion was defined as a ground motion necessary to induce ultimate limit state in a building and the building would collapse.

$$R_{dyn} = \frac{A_{di}}{A_{d0}} \quad (9)$$

where, A_{d0} : intensity of ultimate ground motion before an earthquake (damage class 0)

A_{di} : intensity of ultimate ground motion after damage (damage class “i”)

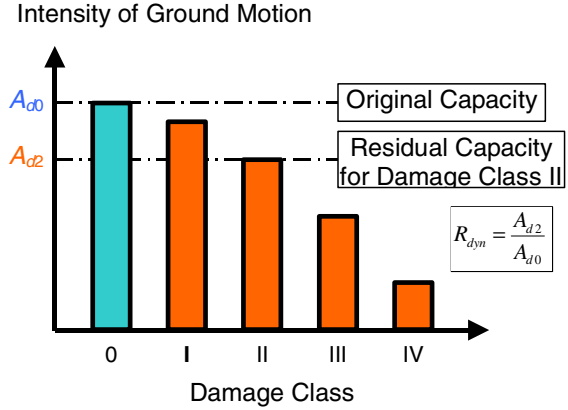

Figure 12: Residual seismic capacity ratio based on seismic response R_{dyn}

Analytical Model

A new model was used to represent the hysteresis rule of the SDF systems; i.e., Takeda-pinning model was modified in order that shear resistance deterioration occurs after some plastic displacement (**Figure 13**). Yield resistance F_y was chosen to be 0.3 times the gravity load. Cracking resistance F_c was one-third the yielding resistance F_y . Initial stiffness K_e was designed so that the elastic vibration periods T were 0.1, 0.2, 0.3, 0.4, 0.5 and 0.6sec. The secant stiffness at the yielding point, K_y , and the post-yielding stiffness, K_u , were 30 and 1 percent of the initial stiffness, respectively.

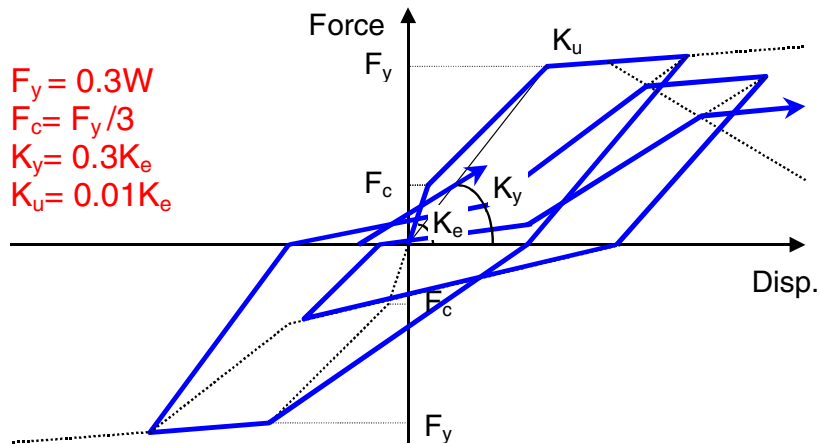

Figure 13: Hysteretic model

Three systems with different ultimate ductility μ_{max} were assumed as shown in **Figure 14** based on authors' column test results [5]. **Figure 14(a)** represents a brittle structure of which ultimate deflection is 2 times yielding deflection ($\mu_{max}=2$). **Figure 14(b)** and **(c)** represent ductile structures with $\mu_{max}=3$ and 5, respectively. The relationship between deflection and damage class was determined in accordance with authors' experimental results as shown in **Figure 14**. The yield resistance F_y started to deteriorate as shown in **Figure 14** after deflection reached to the region of the damage class IV.

Method of Analyses

Four observed earthquake accelograms were used: the NS component of the 1940 El Centro record (ELC), the NS component of the 1978 Tohoku University (TOH), the NS component of the 1995 JMA Kobe (KOB), and the N30W component of the 1995 Fukiui recode (FKI). Moreover, two simulated ground motion with same elastic response spectra and different time duration was used. Acceleration time history and acceleration response spectra are shown in **Figure 15** and **Figure 16**, respectively. The design acceleration spectrum in the Japanese seismic design provision was used as target spectrum and Jennings-type envelope curve was assumed in order to generate the waves. A simulate wave with short time duration is called Wave-S and with long time duration Wave-L. The equation of motion was solved numerically using Newmark- β method with $\beta = 1/4$.

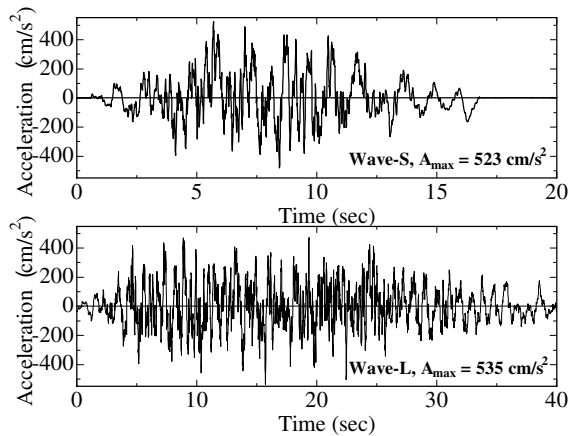

Figure 15: Time history of simulated ground motions

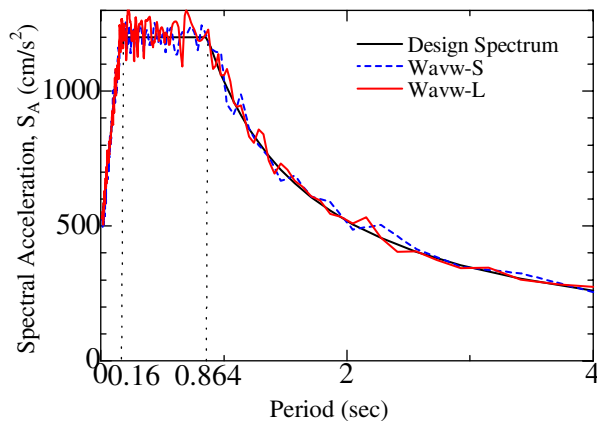

Figure 16: Acceleration spectrum of simulated ground motions

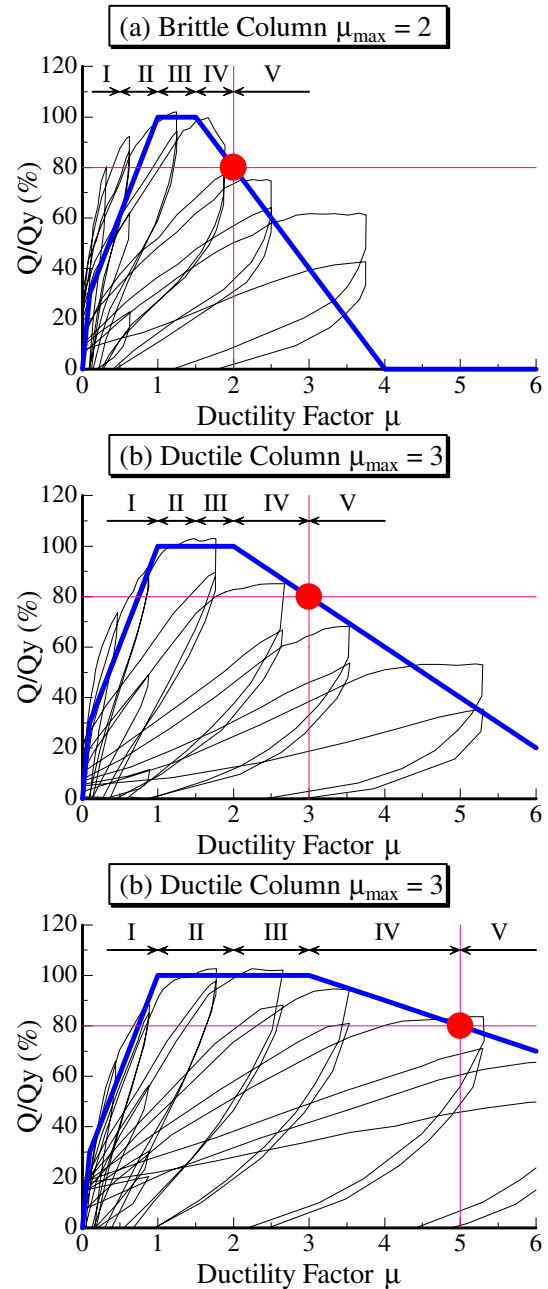

Figure 14: Envelope curve and damage class

Analytical Results

To investigate the relationship between maximum displacement response and intensity of the ultimate ground motion, parametric analyses were run under the six ground motions with different amplification factors. The results for a system with $\mu_{max} = 3$ and $T = 0.2$ sec. under ELC and Wave-S are shown in **Figure 17**. Thick lines indicate results before damage. Ductility factor μ increases with increase in the amplification factor. The lower bound of amplification factor for damage class V is assumed to correspond to intensity of ground motion which induce failure of the structure, and is defined as the intensity of ultimate ground motion before damage, A_{d0} . Ultimate amplification factor for damaged structure, A_{di} , was estimated from analytical results for systems damaged by pre-input. For example, first ductility factor $\mu = 2$ (damage class III) was induced to a system using amplified ground motion, and then additional ground motion was inputted continuously to find the ultimate amplification factors for damage class III, A_{d3} , by parametric studies (**Figure 18**). 0 cm/s² acceleration was inputted for 5 seconds between the pre-input and second ground motion in order to reduce vibration due to the pre-input.

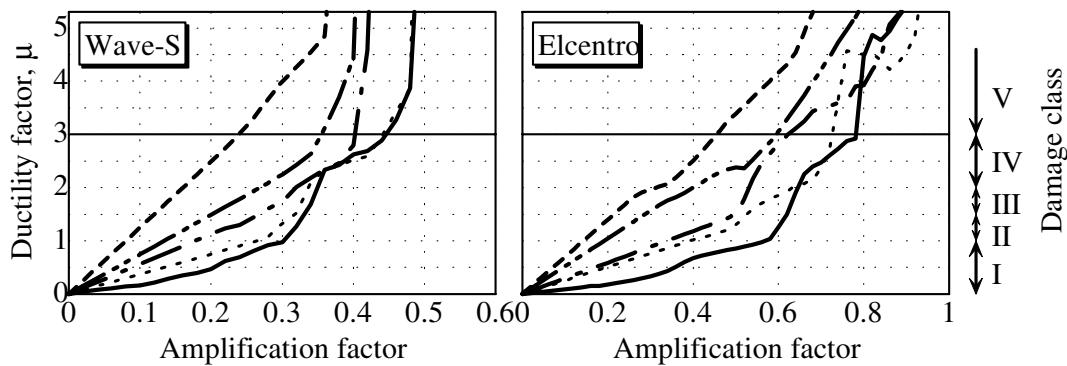

Figure 17: Amplification factor vs. maximum ductility factor

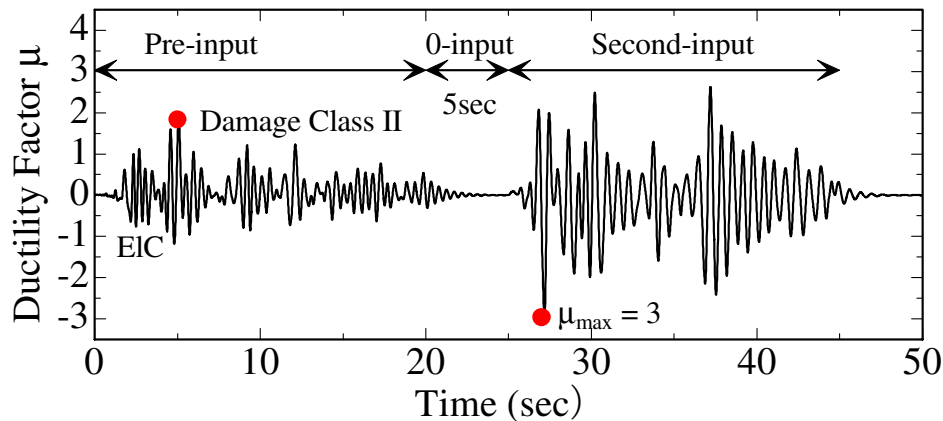

Figure 18: Response time history for a system damaged by pre-input

The residual capacity ratio index R_{dyn} , obtained from analyses of systems with different initial period T under the six ground motions, was shown in **Figure 19**. The reduction factor η in the Guideline (**Table 2**), which is correspond to the R value for a SDF system, was also shown in the figure. As can be seen from the figure, R_{dyn} values based on analyses are ranging rather widely and R -index in the Guideline generally corresponds to their lower bound, although some of analytical results R_{dyn} -index for damage class I are lower than values in the Guideline. Therefore, The Guideline may give conservative estimation of the intensity of ultimate ground motion for a RC building structure damaged due to earthquake.

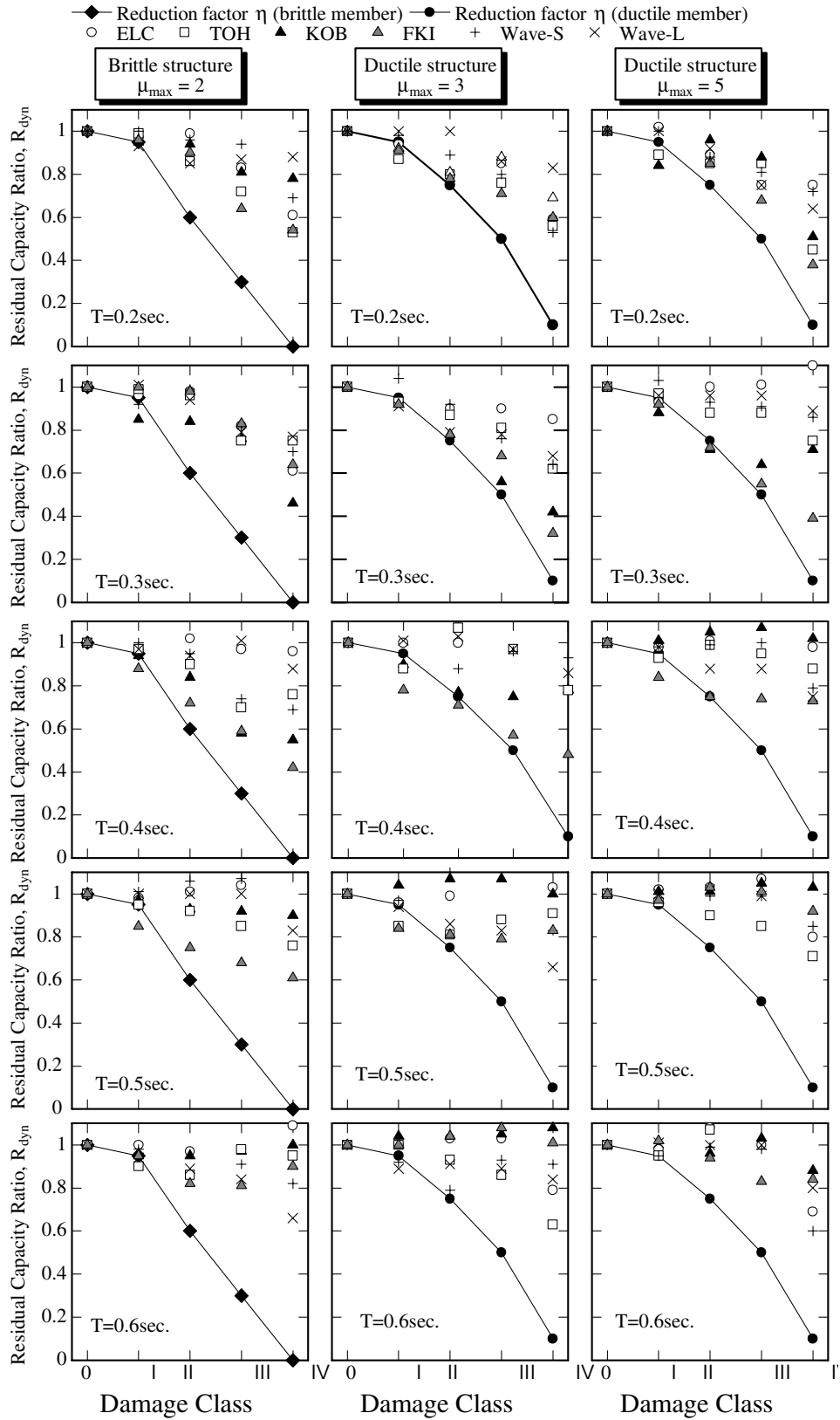

Figure 19: Comparison of residual capacity ratio R_{dyn} with values in the Guideline

CONCLUDING REMARKS

In this paper, the basic concept and procedure of new Guideline for post-earthquake damage assessment of RC buildings in Japan were presented. The concept and supporting data of the residual seismic capacity ratio R -index, which is assumed to represent post-earthquake damage of a building structure, were discussed. Good agreement between the residual seismic capacity ratio R and damage levels classified by engineering judgment was observed for relatively low-rise buildings damaged due to 1995 Hyogo-ken Nambu Earthquake. Moreover, the validity of the R -index was examined through calibration with seismic response analyses of SDF systems. As discussed herein, the intensity of ultimate ground motion for a damaged RC building structure can be evaluated conservatively based on the R -index in the Guideline. Much work is, however, necessary to improve the accuracy of the post-earthquake damage evaluation, because available data related to residual seismic capacity are still few.

REFERENCES

1. JBDPA / The Japan Building Disaster Prevention Association, *Guideline for Post-earthquake Damage Evaluation and Rehabilitation*, 2001. (in Japanese)
2. JBDPA / The Japan Building Disaster Prevention Association, *Standard for Seismic Evaluation of Existing RC Buildings*, 2001. (in Japanese)
3. Bunno, M. and Maeda, M., “*Post-earthquake Damage Evaluation for R/C Buildings based on Residual Seismic Capacity in Structural Members*”, The Third US-Japan Workshop on Performance-based Earthquake Engineering for Reinforced Concrete Building structures, Seattle, 2001.
4. Bunno, M., Komura, N., Maeda, M., and Kabeyasawa, T., “*Experimental study on behavior of reinforced concrete beams under axial restriction* (in Japanese)”, Proceedings of the Japan Concrete Institute, Vol. 21, No. 3, pp.517-522, 1999.
5. Jung, M., and Maeda, M., “*Estimation of residual seismic performance for R/C building damage due to earthquake* (in Japanese)”. Journal of structural engineering, Vol. 46B, AIJ, 2000.

APPENDIX

BASIC CONCEPT OF JAPANESE STANDARD FOR SEIMIC EVALUATION

The Standard consists of three different level procedures; first, second and third level procedures. The first level procedure is simplest but most conservative since only the sectional areas of columns and walls and concrete strength are considered to calculate the strength, and the inelastic deformability is neglected. In the second and third level procedures, ultimate lateral load carrying capacity of vertical members or frames are evaluated using material and sectional properties together with reinforcing details based on the field inspections and structural drawings.

In the Standard, the seismic performance index of a building is expressed by the I_s -Index for each story and each direction, as shown in Eq. (7)

$$I_s = E_0 \times S_D \times T \quad (7)$$

where, E_0 : basic structural seismic capacity index calculated from the product of strength index (C), ductility index (F), and story index (ϕ) at each story and each direction when a story or building reaches at the ultimate limit state due to lateral force, i.e., $E_0 = \phi \times C \times F$.

C : index of story lateral strength, calculated from the ultimate story shear in terms of story shear coefficient.

- F : index of ductility, calculated from the ultimate deformation capacity normalized by the story drift of 1/250 when a standard size column is assumed to failed in shear. F is dependent on the failure mode of structural member and their sectional properties such as bar arrangement, member proportion, shear-to-flexural-strength ratio etc. . F is assumed to vary from 1.27 to 3.2 for ductile column, 1.0 for brittle column and 0.8 for extremely brittle short column.
- ϕ : index of story shear distribution during earthquake, estimated by the inverse of design story shear coefficient distribution normalized by base shear coefficient. A simple formula of $\phi = \frac{n+1}{n+i}$ is basically employed for the i -th story level of an n -storied building by assuming straight mode and uniform mass distribution.
- S_D : factor to modify E_0 -Index due to stiffness discontinuity along stories, eccentric distribution of stiffness in plan, irregularity and/or complexity of structural configuration, basically ranging from 0.4 to 1.0
- T : reduction factor to allow for the deterioration of strength and ductility due to age after construction, fire and/or uneven settlement of foundation, ranging from 0.5 to 1.0.